



Installation / User Manual

APsystems Energy Communication Unit **ECU-R**

Rev 3.0



Please use mobile browser to scan the QR codes to download ECUAPP :



(Android)



(iOS)

© All Rights Reserved

Table of Contents

1. Introduction.....	3
2. Interface Explanation.....	4
2.1 Interface Layout.....	4
2.2 Reset.....	4
2.3 Power Connection Port.....	5
2.4 RJ45 Ethernet Network Port.....	5
2.5 RJ45 Signal (Only for Australia)	5
2.6 Antenna.....	5
2.7 SIM.....	5
2.8 USB port.....	5
2.9 AP.....	5
2.10 LED1.....	6
2.11 LED2.....	6
3. Hardware Installation.....	7
3.1 Preparation.....	7
3.2 Selecting an Installation Location for the ECU-R.....	7
3.3 Installation.....	7
3.4 Cable Connection.....	9
3.5 Internet Connection.....	11
4. ECU-R User Interface.....	12
4.1 Connecting to the ECU-R via the Local Wireless.....	12
4.2 Add UID.....	13
4.3 Delete UID.....	13
4.4 Homepage.....	13
4.5 Data.....	14
4.5.1 Real Time Data.....	14
4.5.2 Power.....	15
4.5.3 Power generation statistics.....	15
4.6 Settings.....	16
4.6.1 Manage IDs.....	16
4.6.2 Grid Profile.....	16
4.6.3 Time management.....	17
4.6.4 Manage the Network Connection.....	18
4.6.5 Manage the WLAN connection.....	18
4.6.6 WLAN PASSWORD.....	19
4.6.7 Language.....	20
4.6.8 Help.....	20
5. Technical Data.....	21
6.Contact Information.....	23

1. Introduction

The APsystems Energy Communication Unit (ECU-R) is the information gateway for our inverters. The unit collects module performance data from each individual inverter and transfers this information to an Internet database in real time, requiring only a single data and power cable. Through the APsystems Energy Monitoring and Analysis software, the ECU-R gives you precise analysis of each inverter and module in your solar installation from APP. The user-friendly interface lets you access your solar array in seconds.

Features

- Collects individual module and inverter statistics
- Communicates in real time
- Requires no additional wiring

The APsystems ECU-R is used in utility-interactive grid-tied applications, and is made up of four key elements:

- APsystems inverter
- APsystems Energy Communication Unit (ECU-R)
ECU-R is part of the system and is the data link to the inverter.
- APsystems APP (ECUAPP)
Based on android and iOS.
- APsystems Energy Monitoring and Analysis (EMA)
Web-based monitoring and analysis system.

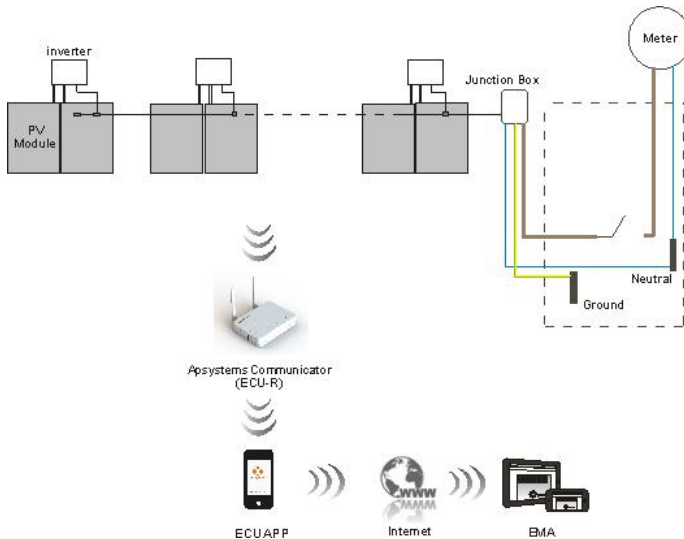

Figure 1

2. Interface Explanation

2.1 Interface Layout

The ECU-R interface includes, (figure 2)from left to right, are Reset、 antenna(Wifi)、 power connection port、 RJ45 Signal port、 RJ45 ethernet network port、 antenna(Zigbee).

The sides from top to bottom ,are SIM port,USB port,AP.

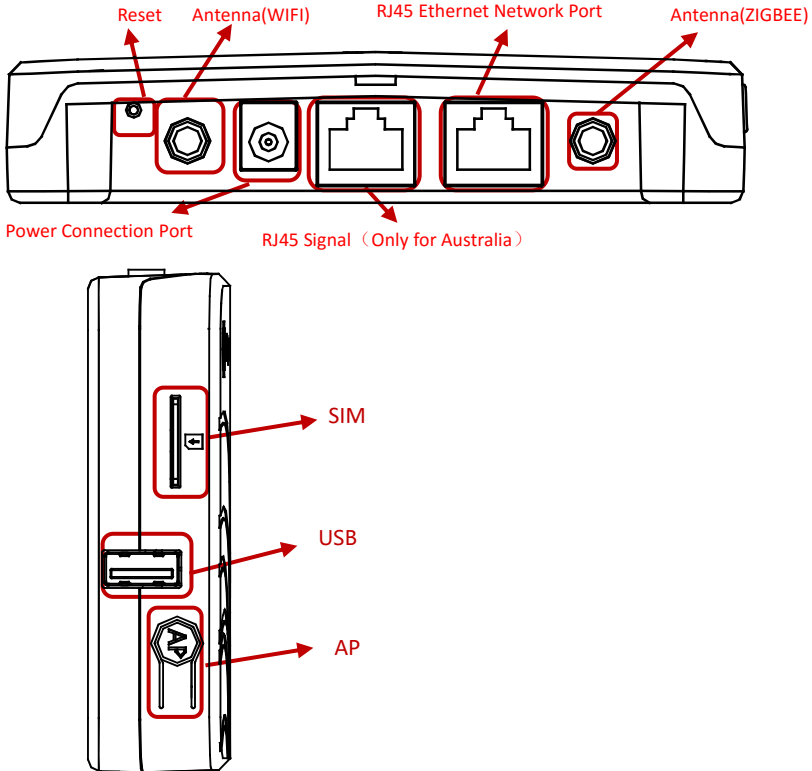

Figure 2

2.2 Reset

Press the Reset button for three seconds or longer, and the ECU-R will automatically return to the default settings.

NOTICE

The wireless password will be changed to '88888888'.

2. Interface Explanation

2.3 Power Connection Port

The power connection port connects power through the power adapter.

2.4 RJ45 Ethernet Network Port

The ECU-R allows the user to communicate with the EMA.

2.5 RJ45 Signal (Only for Australia)

The RJ45 Signal is designed for DRM0, it should be connected by RJ45 connector in the package otherwise the inverter will not work.

2.6 Antenna

The antennas in the package should be connected to ECU-R. One antenna is used for the communication between ECU-R and inverters, the other antenna is used for the Wi-Fi connection between ECU-R and router.

2.7 SIM

The SIM interface is reserved.

2.8 USB port

The USB interface is reserved.

2.9 AP

Press the AP button to turn on AP. Then the ECU-R can be scanned by phone. ECU-R will turn off it automatically in one hour.

2. Interface Explanation

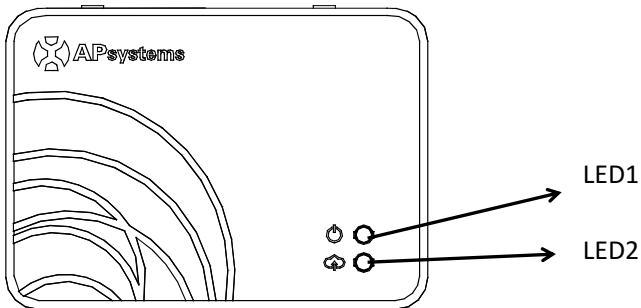

Figure 3

2.10 LED1

LED1 will be on When the ECU-R works well.

2.11 LED2

LED2 will be on When the ECU-R connects to the sever.

3. Hardware Installation

3.1 Preparation

Make sure you have the following components ready before beginning to install the ECU-R:

- A dedicated standard AC electrical outlet (located as close to the array as is possible).
- A broadband Internet connection available for your use.
- A broadband router with either a CAT5 Ethernet, or a wireless router.
- A phone with APP (see page 10).

3.2 Selecting an Installation Location for the ECU-R

- Choose a location that is as close to the array as possible
- The ECU-R is NOT rated for outdoor use, so if installing outdoors near a junction box or breaker panel, make sure you enclose it in an appropriate weatherproof NEMA electrical box.

3.3 Installation

1) Using a Wall Mount

When mounting the ECU-R to a wall, make sure to select a cool, dry indoor location.

- Depending on the wall surface you are mounting the ECU-R to, use either two drywall screws or wall anchors, installed 100 mm apart (The drywall screws and wall anchors are not included in the ECU-R kit).
- Align and slide the ECU-R onto the mounting screws.

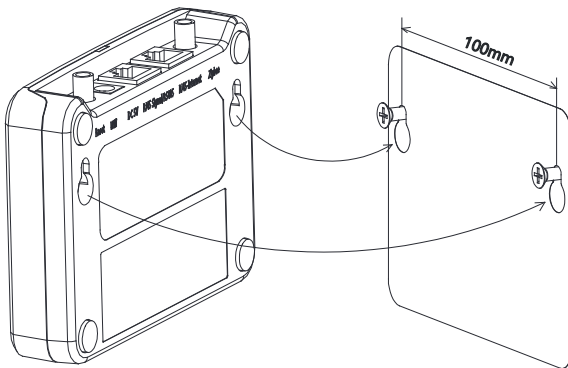

Figure 4

3. Hardware Installation

2) Power Distribution Cabinet Installation

If you use the energy communicator in power distribution cabinet:

- Install the 2 guide rail fasteners on the Guide rail, the space between fasteners shall be 100mm (The guide rail fasteners will not be supplied by APsystems Please prepare it yourself).
- Align and move the ECU-R to the 2 guide rail fasteners.

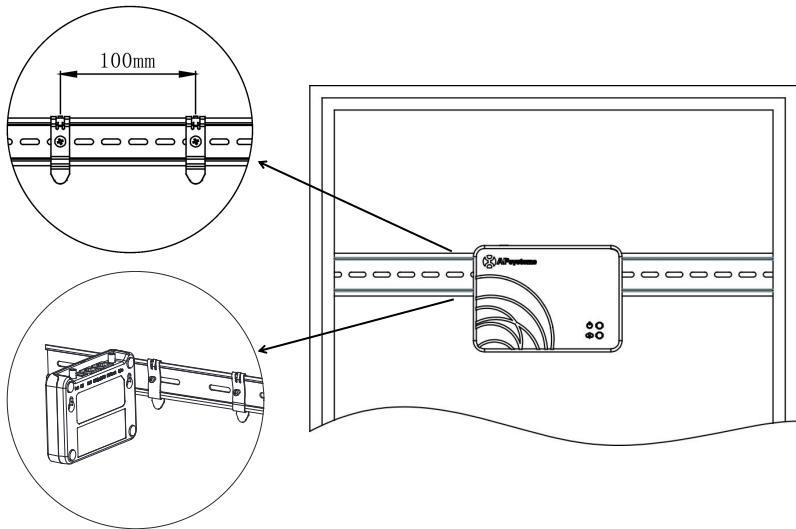

Figure 5

3. Hardware Installation

3.4 Cable Connection

1) Using a Wall Mount

- Connect the adapter to the power connection port on the top of the ECU-R.

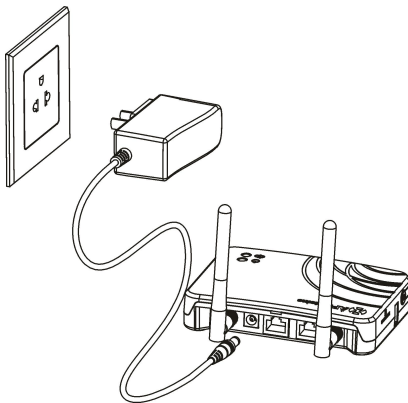

Figure 6

NOTICE

The antennas used for Zigbee port and WI-FI port are exactly the same type, no need to distinguish.

3. Hardware Installation

2) Power Distribution Cabinet Installation

- Install the socket on the guide rail (The socket will not be supplied by APsystems Please prepare it yourself).
- Connect the adapter to the power connection port on the top of the ECU-R.

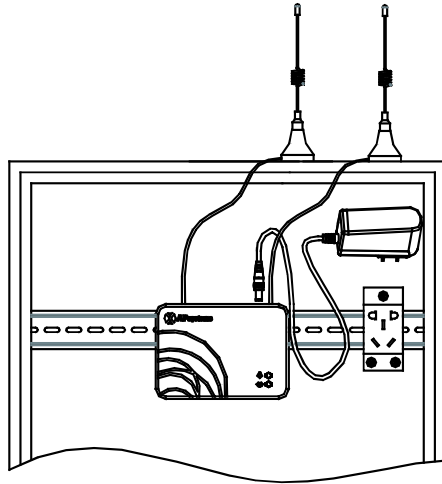

Figure 7



NOTICE

Do not put the antenna inside a metal box, that will block the signal.
If ECU-R is placed in distribution box or the roof is metal, please use this long cable antenna, and put them outside the box or on roof.
The long cable antenna (2.4G) is common in market, can be purchased in electrical store or online store.

3. Hardware Installation

3.5 Internet Connection

There are two different approaches to connecting the ECU-R to the Internet:

Option 1: Direct LAN cable connection.

- 1) Make sure the LAN cable is connected to the network port on the bottom of the ECU-R.
- 2) Connect the LAN cable to a spare port on the broadband router.

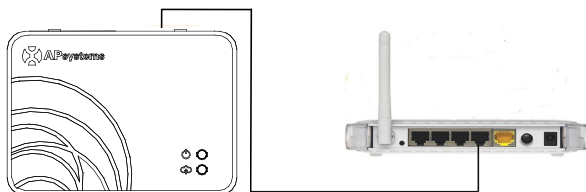

Figure 8

Option 2: Wireless Connection.

Use ECU-R internal WLAN (see Manage the WLAN connection).

4. ECU-R User Interface

Please use mobile browser to scan the QR codes to download ECUAPP :



(iOS)



(Android)

4.1 Connecting to the ECU-R via the Local Wireless

- Open Wi-Fi setting in your smartphone, select ECU-R hotspot.
- Connecting to the ECU-R via the Local Wireless, the default password is "88888888".
- Open the ECUAPP.
- Check ECUAPP is connected to ECU-R in the Home page.

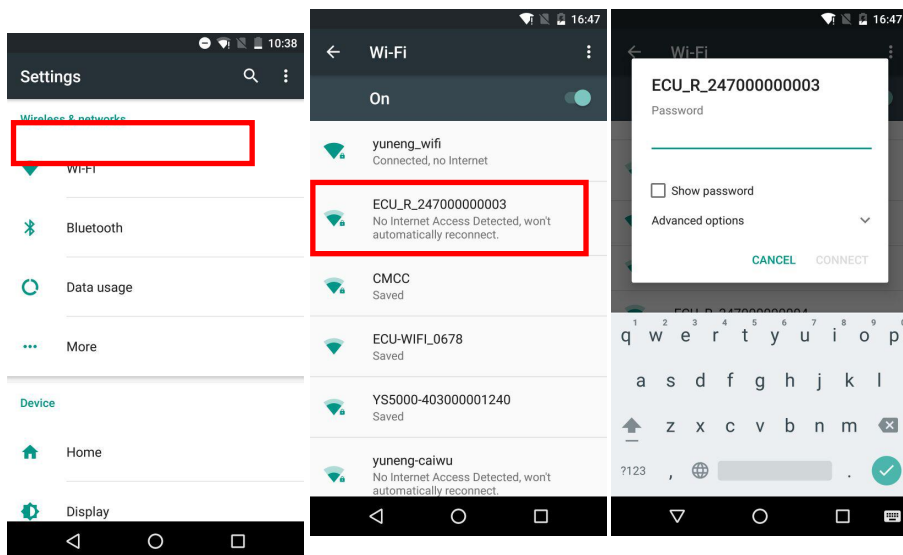

NOTICE

Before the first time to add the UID, users must set the date and time in advance. Please refer to the 4.6.2 Time Management.

4. ECU-R User Interface

4.2 Add UID

- Click "Settings", select "ID Management", input the UID manually or scan the UID by camera. If there is no need to modify, then click "SYNC" to update the UIDs onto ECU.

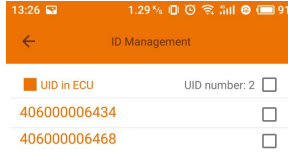
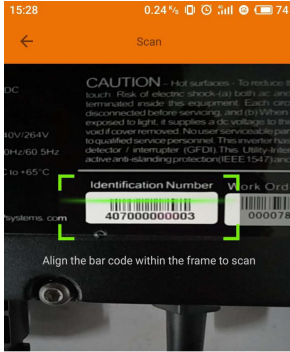

4.3 Delete UID

- Select the UIDs, click "DELETE" then click "SYNC". The UIDs selected are deleted on the ECU-R.



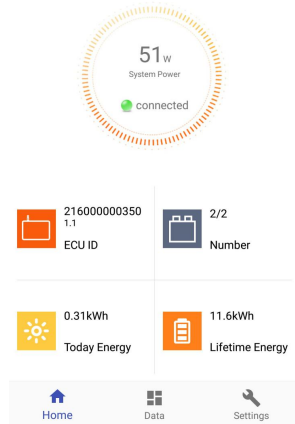

4.4 Homepage

- Click "Home" at the bottom of the page. The information about systems info of ECU-R, ECU-R ID, version, total number of inverters, the number of connected inverters, intraday power output, historical Power output and current system power shall be displayed.



4. ECU-R User Interface

-  Green light indicates the mobile phone is connected to the ECU-R.
-  Grey light indicates the mobile phone fails to connect to the ECU-R.

4.5 Data

4.5.1 Real Time Data

- This page shall display the added inverter. According to different models of inverter, each inverter would have the corresponding modules displaying the real time power.
- Click "Module", the detailed information of the inverter shall be displayed, including inverter ID, PV module power, grid voltage, frequency and temperature.

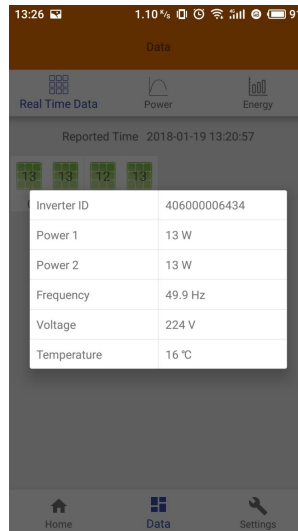
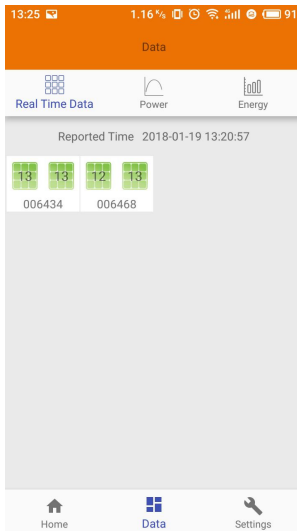

Green panel indicates the inverter is successfully connected.



Grey panel indicates the inverter is disconnected.

4. ECU-R User Interface

4.5.2 Power

- To This page displays the daily system power curve. Click "Power" at the real time data page to view the historical system power curve.

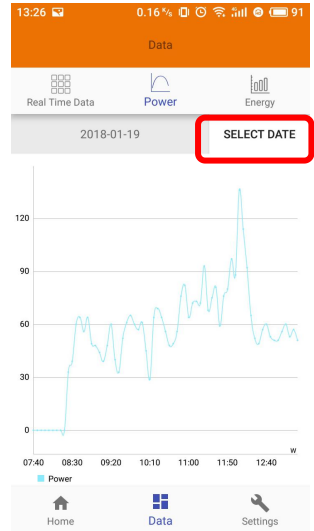

4.5.3 Power generation statistics

- Press "Energy" at the real-time data page to view the system power generation of the solar system.

The statistics of power generation shall be displayed.

The energy histogram of current week:

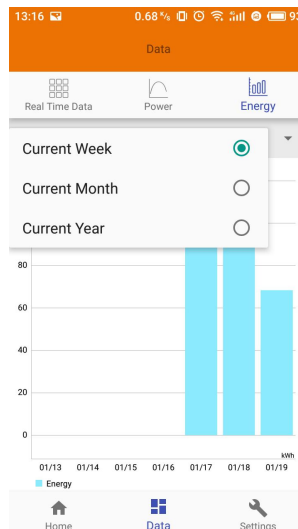
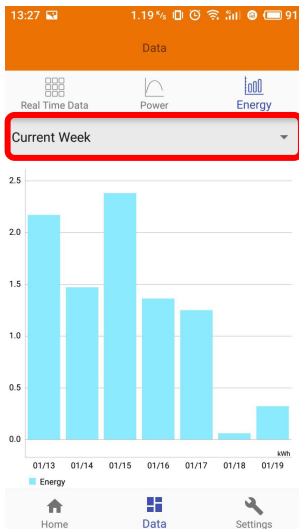

4. ECU-R User Interface

4.6 Settings

- Click "Settings" and enter into the "settings page".

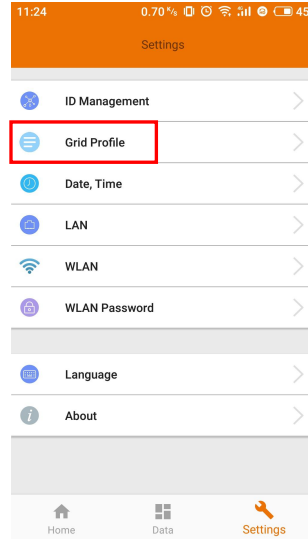

4.6.1 Manage IDs

- Please refer to 4.2 to add UID.

4.6.2 Grid Profile

- Enter the Grid Profile page, you can select the grid profile for inverters. Select the grid profile, modify the parameters if it is needed and click Update.

NOTICE

If you select the wrong grid profile, the inverters will not work normally.

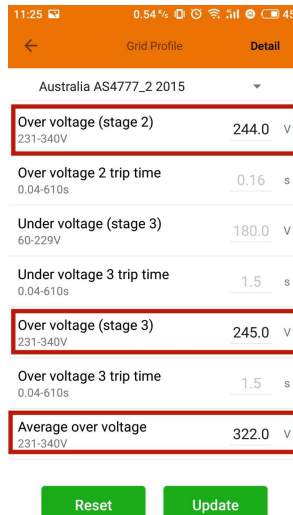
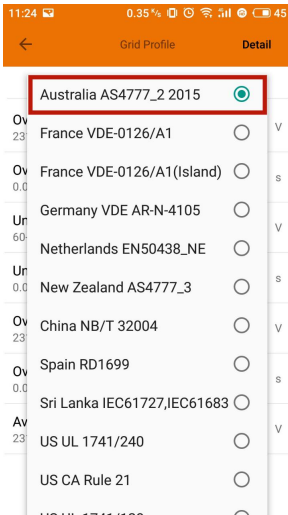

4.ECU-R User Interface

- Enter the Detail page, you can view the inverters' parameters. Click Read, ECU will get the parameters from inverters. You can swipe down the ID list to view the result after about 5 minutes later.

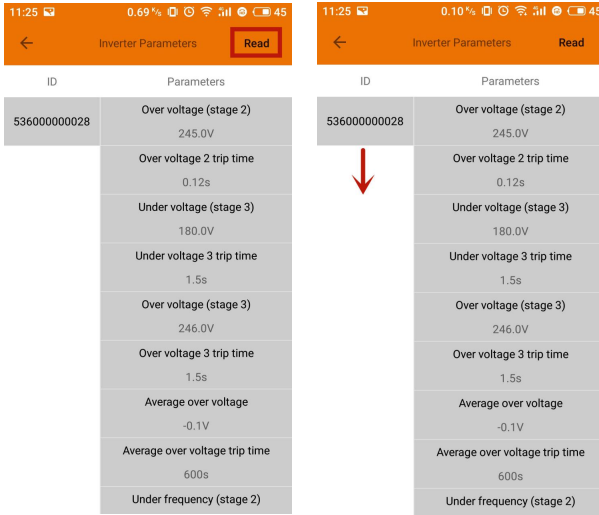

4.6.3 Time management

- Enter the page, the time of ECU-R shall be displayed on the right side of the page. Click "date" or "time" to modify.

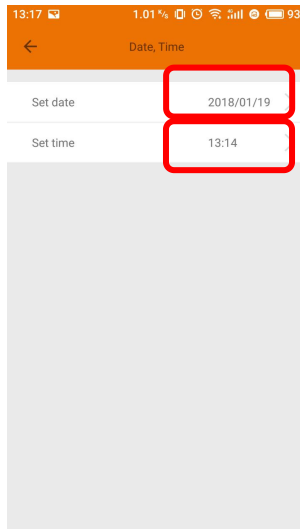

4.ECU-R User Interface

4.6.4 Manage the Network Connection

- ECU-R's wired network setting has 2 options: automatically obtain an IP address or use a fixed IP address. Obtaining an IP address automatically means the router would distribute IP to ECU-R automatically. When choose user fixed IP, users shall use the following IPs.

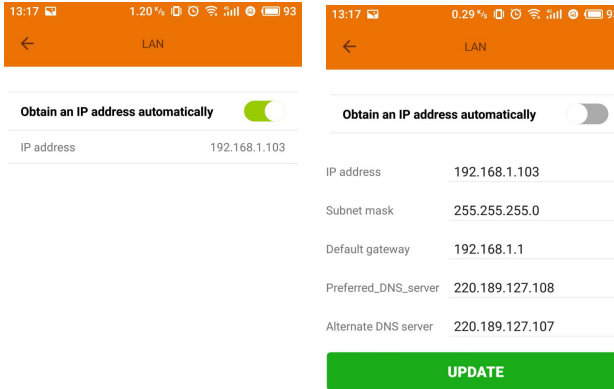

4.6.5 Manage the WLAN connection

- The page will show up ECU's wireless connection status. Click "Refresh" button, the available SSID would show up.
- Click the SSID and enter the password.
- The ECU-R would restart after sending the password. Please reconnect the ECU-R.

4. ECU-R User Interface

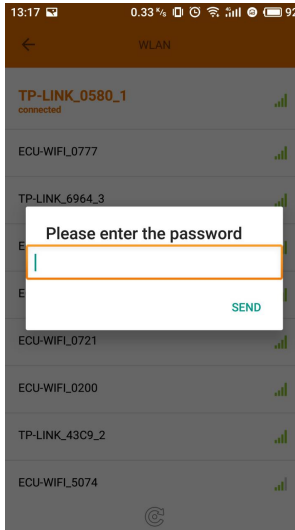
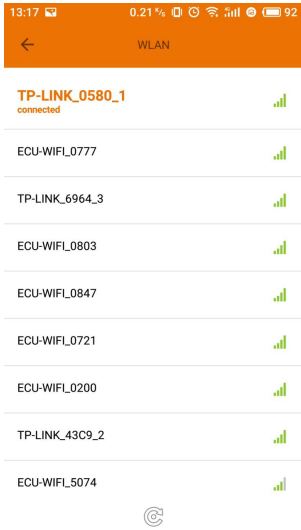

NOTICE

After the password is sent, ECU-R will restart. Please reconnect to ECU-R.

4.6.6 WLAN PASSWORD

- Please reconnect the ECU-R hotspot after setting the password. On the page, you can change Password.
- If user forget the password, hardware reset could be carried out. The initial password would be "88888888".

A screenshot of the ECU-R WLAN PASSWORD interface. The top bar is orange with a back arrow, the text 'WLAN PASSWORD', and the battery level '92'. Below the header is a message: 'Please reconnect the ECU's hotspot after setting the password'. There are three text input fields: 'Old Password' with the placeholder 'Input old password', 'New Password' with the placeholder 'Input password', and 'Confirm' with the placeholder 'Input password again'. At the bottom is a green button labeled 'UPDATE'.

4. ECU-R User Interface

4.6.7 Language

Select Language.

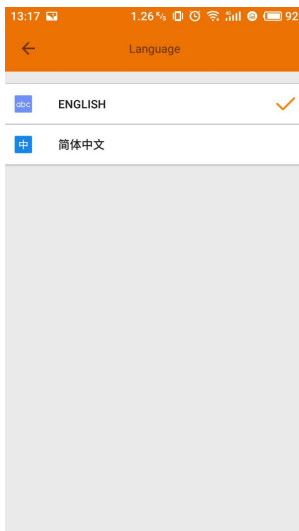

4.6.8 Help



Introduction

This smart phone application is designed to control and monitor an APsystems ECU as part of an APsystems solar microinverter system. App users can see the working status of the ECU and its inverters and can reset the device configuration.

The APsystems Energy Communication Unit (ECU) is the information gateway to and from APsystems solar microinverters. The unit collects module performance data from each microinverter unit and transfers this information to an online database in real time, requiring only an internet connection (via wired CAT5 or Wi-Fi) and power cable. Through the APsystems Energy Monitoring and Analysis (EMA) cloud-based service, the ECU gives the homeowner precise analysis of each microinverter and module in their solar installation.

Features:

- See the status and configuration of the ECU gateway and monitor each inverter.

- Display real-time energy production and other performance data

5. Technical Data

Model: ECU-R	
Communication Interface	
Integrated Wi-Fi	802.11g/n
Antenna	Standard 2.4G
Power Requirements	
AC Adapter	110~240 VAC, 50~60 Hz 5V 2A
Power Consumption	1.7W
Mechanical Data	
Dimensions (W×H×D)	122mm×87mm×25mm
Weight	150g
Ambient Temperature Range	-20°C to +65°C
Cooling	Nature Convection; No Fans
Enclosure Environmental Rating	Indoor - NEMA 1(IP20)
Features	
Compliance	IEC 60950-1, EN60950-1, IEC 60529, EN 60529, ANSI/UL 60950-1, CAN/CSA C22.2 No.60950-1, UL50E, FCC part 15, EN61000-6-1, EN61000-6-3, ICES-003, AS NZS 60950-1, GB/T17799

Specifications subject to change without notice.

Please ensure you are using the most recent update found at www.APsystems.com.

This device complies with part 15 of the FCC Rules. Operation is subject to the following two conditions: (1) This device may not cause harmful interference, and (2) this device must accept any interference received, including interference that may cause undesired operation.

This Class B digital apparatus complies with Canadian ICES-003.

2019/1/11 REV3.0

:: WEEE (for Europe)



Disposal of your old appliance

1. When this crossed-out wheeled bin symbol is attached to a product, it means the product is covered by the European Directive 2002/96/EC.
2. All electrical and electronic products should be disposed of separately from the municipal waste stream via designated collection facilities appointed by the government or the local authorities.
3. The correct disposal of your old appliance will help prevent potential negative consequences for the environment and human health.
4. For more detailed information about disposal of your old appliance, please contact your city office, waste disposal service or the shop where you purchased the product.

CAUTION

The professional person is allowed to replace the battery.

Do not ingest battery, Chemical Burn Hazard.

This product contains a coin/button cell battery. If the coin/button cell battery is swallowed, it can cause severe internal burns in just 2 hours and can lead to death. Keep new and used batteries away from children. If you think batteries might have been swallowed or placed inside any part of the body, seek immediate medical attention.

6.Contact Information

ALTENERGY POWER SYSTEM Inc.

www.APsystems.com

APsystems Jiaxing China

No. 1, Yatai Road, Nanhu District, Jiaxing, Zhejiang

Tel: +86 573 8398 6967

Mail: info@altenergy-power.com

APsystems Shanghai China

B403 No. 188, Zhangyang Road, Pudong, Shanghai

Tel: +86 021 3392 8205

Mail: info@altenergy-power.com

APsystems Australia

Suite 502, 8 Help Street, Chatswood NSW 2067 Australia

Tel: +61 (0)2 8034 6587

Mail: info@altenergy-power.com

APsystems America

600 Ericksen Ave NE, Suite 200 Seattle, WA 98110

Tel: 844-666-7035

Mail: info@APsystems.com

APsystems Europe

Rue des Monts dor ZAC de Follieuses Sud-Les Echets 01700 Miribel, France

Tel: +33-481 65 60 40

Mail: emea@APsystems.com